

Learning Journal

Chain Saw Basic

Lesson 430-136

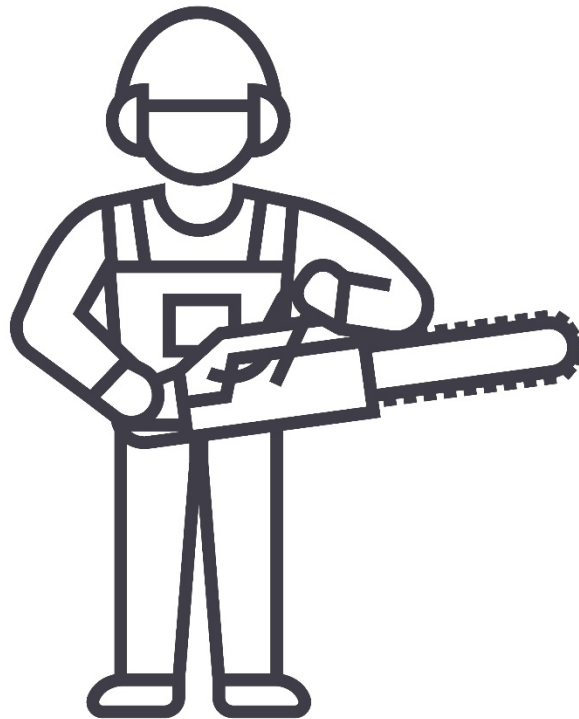

Name: _____

Date: _____

This training expires after 5 years, and participants will need to retake the course preferably before their expiration date.



Chain Saw Basic: Lesson 430-136: Learning Journal

©2019 Scouting U, Boy Scouts of America

All rights reserved. No part of this product may be reproduced, distributed, or transmitted in any form or by any means, including photocopying, recording, or other electronic or mechanical methods, without the prior written permission of the publisher.

Document Revision

Document Revision Date: 07/29/21

TABLE OF CONTECTS

| | |
|---|----|
| Personal Protective Equipment | 6 |
| The Chain | 7 |
| The Guide Bar..... | 8 |
| Chain Saw Safety Manual..... | 9 |
| Sharpening the Chain on Your Chainsaw..... | 11 |
| Field Maintenance Tool Kit | 12 |
| Daily Saw Maintenance..... | 12 |
| Weekly Saw Maintenance..... | 13 |
| Monthly Saw Maintenance..... | 13 |
| Troubleshoot a chainsaw: Know your equipment and how to troubleshoot in the field.... | 13 |
| Method 1 | 16 |
| Method 2 | 17 |
| Standing Start..... | 17 |
| How To Start a Chainsaw | 17 |
| Stance when operating a chainsaw | 18 |
| Kickback | 19 |
| Avoiding Kickback | 19 |
| Pull-in | 20 |
| Avoiding Pull-in | 20 |
| Pushback | 20 |
| Avoiding Pushback..... | 20 |
| Reactive forces..... | 20 |
| Spotters..... | 21 |
| Keep Your Distance | 21 |
| Safety Reminders for Tree Felling..... | 22 |
| Know Your Limits | 23 |
| Know when to turn down a felling project..... | 23 |
| Go/No Go Checklist for Chain Saw Operations..... | 24 |
| Felling Plan Outline | 25 |

| | |
|---|----|
| Size up area to work in..... | 25 |
| Escape Route..... | 26 |
| Prepare escape route..... | 26 |
| Danger Zone..... | 27 |
| Gunning sight | 31 |
| Bucking a Felled Tree | 33 |
| Bucking: Top Bind | 34 |
| Bucking: Bottom Bind | 34 |
| End bind | 34 |
| Reactive forces..... | 35 |
| Limbing..... | 36 |
| Appendix A..... | 37 |
| Annual Health and Medical Record | 37 |
| Appendix B..... | 40 |
| Glossary of Terms..... | 40 |
| Appendix C..... | 55 |
| BSA SAFETY MOMENT: CHAIN SAW SAFETY | 55 |
| Appendix D..... | 56 |
| BSA SAFETY MOMENT: ANNUAL HEALTH AND MEDICAL RECORD (AHMR)..... | 56 |
| Appendix E | 57 |
| BSA SAFETY MOMENT: HAZARD TREES | 57 |
| Appendix F | 58 |
| BSA SAFETY MOMENT: HAZARD TREES AND HAMMOCKS – JACK’S STORY | 58 |
| Appendix G..... | 59 |
| Practical Activity Checklist | 59 |

National Camp Standards

| | |
|--|---|
| FA-712 | TREE REMOVAL AND CHAIN SAW OPERATION (Revised January 1, 2020) |
| STANDARD: Trees must be felled and chain saws used in a safe manner. | Applies to: |
| Specific Requirements of the Standard: <ul style="list-style-type: none">A. Persons felling trees more than 6 inches in diameter by any means must be approved by the council designee. All tree cutting must be properly supervised, and a spotter must be present.B. Any person who operates a chain saw must be approved by the council designee.C. Chain saw operators must be at least 21 years old and meet one of the following requirements:<ul style="list-style-type: none">1. Be a professional forester with current credentials and liability insurance.2. Be a certified arborist with credentials.3. Have written documentation of training in chain saw techniques from one of the following: (a) a state or federally recognized chain saw training course approved by the council; or (b) the BSA Chain Saw Basic Training course, No. 430-136.D. Individuals using chain saws are equipped with the following safety gear:<ul style="list-style-type: none">1. An appropriate first-aid kit is within easy access2. High-top boots, preferably leather3. Long pants4. Leather work gloves (or equivalent)5. Eye protection—ANSI-compliant safety glasses, goggles, or face shield6. Hearing protection7. Hard hat8. Chain saw chaps INTERPRETATION: <p>Camps that fell trees off camp property must comply with the requirements of the land owner or land manager and this standard. A state or federally approved chain saw course is, for example, training offered to U.S. Forest Service or state forestry personnel or volunteers in chain saw use.</p> VERIFICATION: <ul style="list-style-type: none">• Discussion with camp staff REFERENCES: <ul style="list-style-type: none">• The BSA Chain Saw Basic Training course is available on the Outdoor Programs website at www.scouting.org/outdoor-programs/ | <ul style="list-style-type: none">Camp propertiesDay campShort-term campLong-term camp <p>FA-712-1</p> |

Personal Protective Equipment

At a minimum, the following personal protective equipment (PPE) is needed to prevent or lessen the severity of injury.

- An appropriate first-aid kit is within access
- Foot Protection – High-top boots, preferable leather; steel toe / cut resistant boots
- Leg Protection – Cut resistant Chain Saw chaps and long pants
- Hand Protection – Leather work gloves (or equivalent)
- Eye / Face Protection – ANSI-compliant safety glasses, goggles and/or logger type mesh screens or face shield
- Head protection - Hard hat
- Hearing protection - Earmuffs or plugs

Chainsaw Chic

There's a lot of new safety gear for chainsaw users. Our reporter tries them on.

HEAD: All-in-one helmet and ear protection system saves head from wayward branches and ears from whine of motor. (\$42.95 from Husqvarna)

EYES: Many helmets have brush shield protectors that flip up, but it's a good idea to don goggles or sunglasses underneath—lest you forget to flip it back down.

HANDS: Gloves with bolstered grip protection help you hang on; some also have cut-retardant material sewn in. (\$17.99 from Echo)

BODY: First-timers should consider a protective shirt with tough material such as Engtex. (\$59.95 from Stihl)

LEGS: Chaps with Kevlar (see inset) and other threads can clog and halt chain instantly upon contact. (\$45.95 from Husqvarna)

FEET: Think traction. Wear boots with nonskid soles and (not pictured) steel toes.

Barbara J. Norman (photographer); Dan Pieper (illustration)

First Aid

The onsite first-aid kit must have supplies that meet Occupational Safety and Health Administration (OSHA) specifications and requirements. A Type IV first-aid kit must be available as a minimum (General Services Administration national stock number NSN 6545-01-010-7754).

Sherrill Tree item #28212 can be added to a regular first aid kit to make it chain saw specific.

<https://www.sherrilltree.com/sherrilltree-saddle-side-blood-stopper-first-aid-kit>

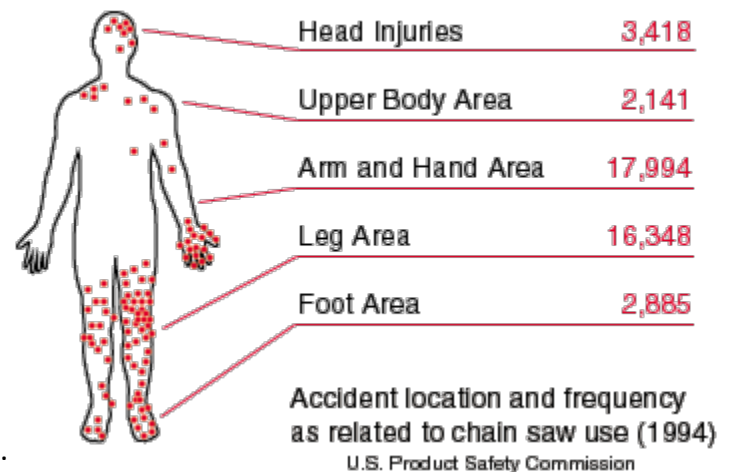

Chain Saw

The Chain

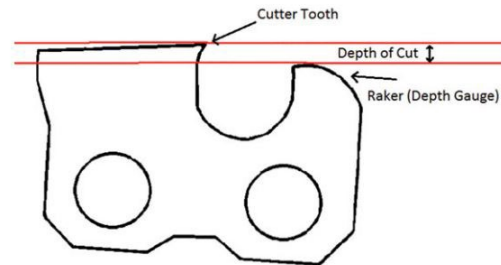
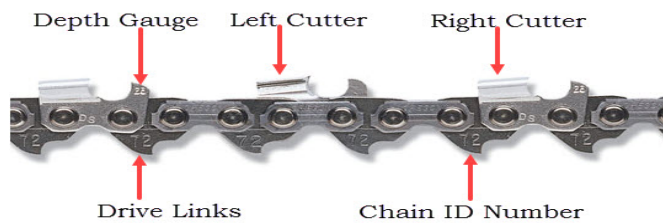

Selecting the proper chain is important for operating a chain saw safely. The saw chain is made up of several parts that work together and must be properly maintained for maximum performance and safety. The cutter is the part of the saw chain that does the cutting. The saw chain has left-hand and right-hand cutters so that the saw chain will cut evenly through the wood.

The depth gauge (or raker) on the cutter determines the depth of the cut. The cutting corner on the top plate of the cutter severs the cross grains. This is the hardest part of the work. The top plate's cutting-edge chisels and removes the severed wood fibers, creating the kerf.

Tie strap: Holds the parts of the saw chain together. Over time, rivet holes on the tie strap will elongate and the chain will become loose and will need to be tightened.

Drive link: Fits in the bar groove so the bar can guide the chain, and into the chain sprocket so the power head can drive the chain around the bar. Draws oil from the bar groove to lubricate the bar and chain.

Master link: A special drive link that is used to join both ends of the chain when building a loop of chain from a roll. They are typically yellow in color for easy identification. There should be no more than two master links in any chain.

Pitch: The measurement between two rivets divided by two (i.e. 3/8 found on the bar)

Number of drivers – 84 for a 24-inch bar (found on the bar).

Gauge: the thickness of the drive link tang (maybe marked on the side of the drive link).

The Guide Bar

The Guide bar supports and guides the saw chain. The most common types of bars are solid nose (or “tip”) and sprocket nose (or “roller tip”).

A solid nose bar is usually found on small saws. The bar is solid without a sprocket.

A sprocket nose bar has a sprocket (a toothed wheel) in the nose to reduce drag and help the chain move freely around the bar.

A reduced-weight bar has a lightweight insert to reduce the weight. Although lighter, reduced-weight bars tend to be more fragile.



Parts of a Chain Saw

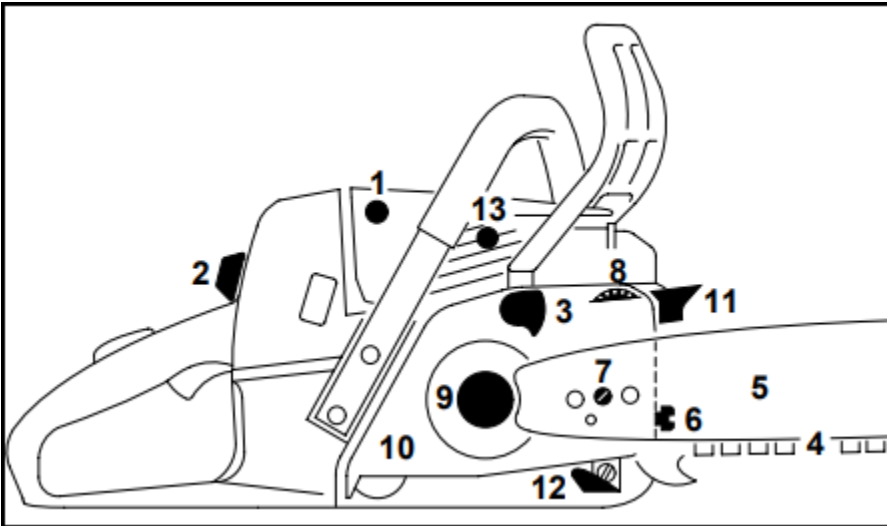

- 1 = Fuel pump (easy start*)
- 2 = Twist lock
- 3 = Chain brake
- 4 = Saw chain
- 5 = Guide bar
- 6 = Front chain tensioner
- 7 = Side chain tensioner
- 8 = Adjusting wheel of quick tensioner *)
- 9 = Chain sprocket
- 10 = Chain sprocket cover
- 11 = Bumper spike
- 12 = Chain catcher
- 13 = Decompression valve (easy start*)

*) Special option

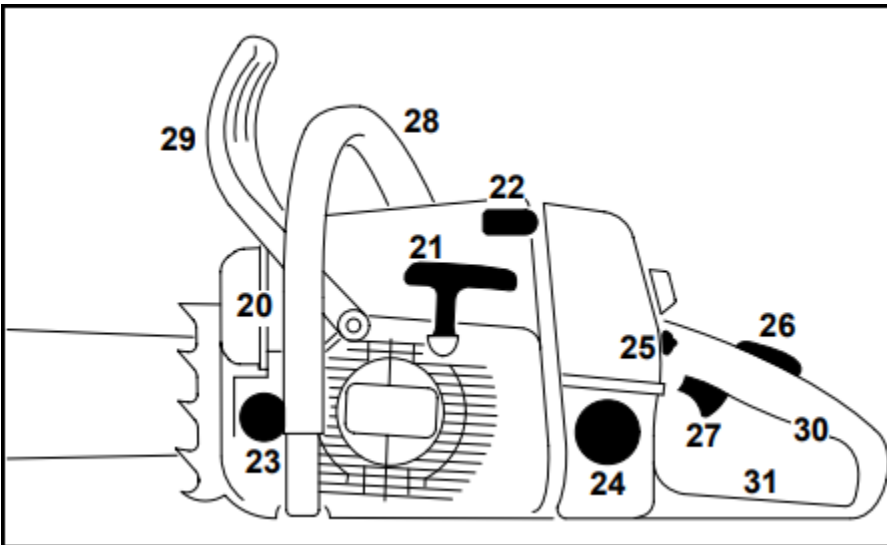

- 20 = Muffler
- 21 = Starter grip
- 22 = Spark plug terminal
- 23 = Oil filler cap
- 24 = Fuel filler cap
- 25 = Master control lever
- 26 = Throttle trigger interlock
- 27 = Throttle trigger
- 28 = Front handle
- 29 = Front hand guard
- 30 = Rear handle
- 31 = Rear hand guard

Chain Saw Safety Manual

https://www.stihl.com/p/media/download/uk-en/STIHL_Chain_Saw_Safety_Manual.pdf

NOTES:

Chain Maintenance

1. **The chain must be _____.** When the chain is sharp, the chain does the work. When the chain is dull, you do the work, making you fatigued and increasing the wear on the bar, chain, and power head.
2. **The _____ must be set correctly.** The gauges' depths and shapes are critical to the saw's performance and your safety.
3. **The chain must be tensioned correctly.** More bar and chain problems are caused by incorrect chain tension than by any other single condition.
4. **The chain must be well lubricated, using only bar and chain oil.** The bar, chain, and nose need a steady supply of oil. Otherwise, the bar and chain will be subject to excessive wear and damage. Several conditions can increase the chain's potential for kickback, the risk of throwing or breaking the chain, or the risk of other hazards.

Look for these conditions when inspecting your chain saw:

- Loose chain tension
- Incorrect chain cutter angles (caused by improper filing)
- Dull chain
- Alteration of chain features designed to reduce kickback
- Incorrect depth gauge (raker) settings (generally too low)
- Improper shape of depth gauges (rakers) after filing
- Incorrectly installed chain parts
- Loose rivets, or cracks and breaks in any chain part
- Chain stretched beyond usable limits.

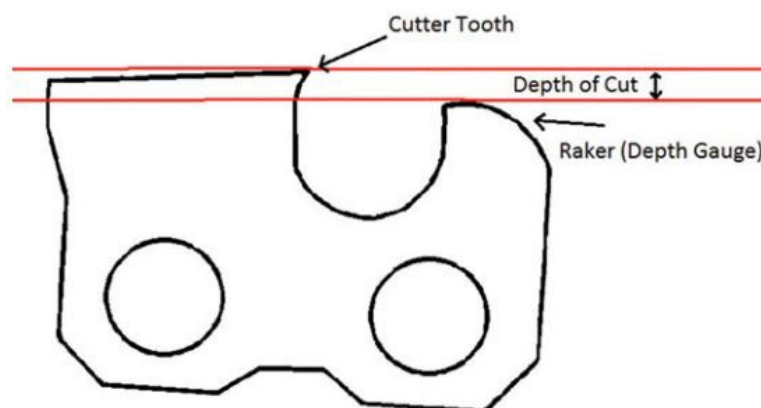

Chain Sharpening

Select a file that is the proper diameter for the saw chain, 7/32 inch is the most common size.

After the saw chain has been hand filed a few times, it should be ground on a chain grinder to restore angles that may have changed during hand filing and to grind all cutters to the same length.

Understanding how a cutter works will help you see why proper chain maintenance is so important.



The depth gauge rides on the wood and controls the depth at which the cutting corner bites into the wood.

The cutting corner and side plate sever the cross grains.

The top-plate cutting angle (25-35 degrees) pushes the cutter to the side, creating the kerf. The chisel angle (directly under the top plate) chisels out the severed wood fibers, lifting them from the kerf.

Three angles must be maintained when filing or grinding a saw chain: the top-plate cutting angle, depth gauge setting, and side-plate angle.

When sharpening the cutters with a round file, be sure the chain is tensioned properly. The file must be held at least one-fifth of the file's diameter above the cutter's top plate.

(DEMONSTRATE) The clamp-on file guide (or jig) positions the file correctly. Maintain the correct top-plate angle (as marked on the file guide) by keeping the filing angle parallel with the chain.

Sharpening the Chain on Your Chainsaw

<https://www.youtube.com/watch?v=HaAw0K0CAV0&list=PLI4vq6YVXbdqipnfuOGw8pKP9uCtgYciA#action>

Chain Saw Maintenance

Field Maintenance Tool Kit

- Srench—A combination screwdriver and wrench designed for chain saw maintenance
- Small screwdriver—For carburetor adjustments
- Plastic wedges
- Round file—Use the appropriate diameter
- Flat mill bastard file—For filing the rakers
- Grease—For lubricating the bearing and sprocket tip guide bars
- Star wrench—For various screws and bolts on your saw
- Extra spark plug—Replace if pitted or fouled
- Extra starter cord—Carry approximate length needed
- Extra chain—Use appropriate size, drivers, and gauge of chain
- Extra parts—Needle cage bearing, washer, E-clips, sprocket, bar nuts
- Air filter—Replace when badly soiled

Daily Saw Maintenance

- Check the throttle trigger for smooth operation. Be sure the trigger cannot be pulled until the throttle trigger lockout is depressed.
- Clean the chain brake and check that it engages and disengages properly.
- Clean or replace the air filter as necessary. Check for damage and holes.
- The guide bar should be turned daily. Check the chain oil hole in the bar to be sure it is not clogged. Clean the bar groove. Lubricate the sprocket tip on the bar.
- Check the chain oiler to be sure the bar and chain receive proper lubrication.
- Sharpen the saw chain and check its tension and condition. Check the sprocket for wear; replace if necessary.
- Check the starter cord and assembly for damage and wear. Clean the air intake slots on the starter housing.
- If necessary, retighten loose nuts and screws, using proper tools and taking care not to damage threads or crack casings.
- Test the ignition switch to be sure it shuts off the engine.

Weekly Saw Maintenance

- Check antivibration shock-absorber systems for damage and wear.
- Check and lubricate the clutch drum bearing.
- File off any burrs on the side of the guide bar.
- Clean the spark plug and check the gap.
- Check the starter assembly and rewind the spring for proper tension.
- Clean the flywheel fins.
- Clean the cooling fins on the cylinder.
- Remove carbon buildup on the muffler screen. Change the screen when mesh openings exceed 0.025 inches (0.06 cm).
- Clean the carburetor body and under the air filter cover.

Monthly Saw Maintenance

- Check the chain brake for wear. If tools and skill are available, check the clutch center, clutch drum, and clutch springs for wear.
- Check the fuel filter; change if necessary. Flush the chain oil tank with gasoline.
- Flush the inside of the fuel tank with gasoline.
- Check all wires and connections.

Troubleshoot a chainsaw: Know your equipment and how to troubleshoot in the field.

https://www.youtube.com/watch?v=2rWgPe_Ecrg&feature=youtu.be

NOTES:

Fueling a Chain Saw



_____ the saw and allow it to _____ for a few minutes before fueling.

Clear an area on the ground for the saw to be positioned correctly.

Wipe dirt and wood chips off of the fuel tank cap and surrounding areas.

Slowly loosen the cap, allowing any built-up pressure to escape.

Use an approved safety fuel container with a funnel or spout to help avoid spillage.

After fueling, replace the fuel cap, making sure the threads are not crossed and the cap is placed on securely.

Councils should have a plan in place to ensure a high level of quality when mixing fuel.

Fuel used should be from a high grade, recommend 91 octane with no Ethanol.

While the saw is cool and not running for fueling, remember these few maintenance points.

- Always fill the chain oil reservoir. Wipe off the reservoir cap to prevent contamination.
- Always check chain tension.
- Always clean the air filter.

Safely Transporting a Chain Saw

First, Transporting Chain Saws *in a Motor Vehicle* you must:

Keep the bar and chain covered with a chain guard.

Properly secure the chain saw to prevent it from being damaged and to prevent fuel from spilling.

Never transport a chain saw or fuel in a vehicle's passenger compartment.



When you Transport Chain Saws *When on Foot* remember:

The muffler and power head can reach extremely high temperatures. Avoid contact with these areas when carrying a saw that has been used recently.

When carrying the saw for short distances, more than two steps, let the saw idle down, and set the chain brake.

When carrying the saw more than 50 feet (or in hazardous conditions such as on slippery surfaces or through heavy underbrush), turn off the saw and carry it in a way that prevents contact with the chain, muffler, and dogs.

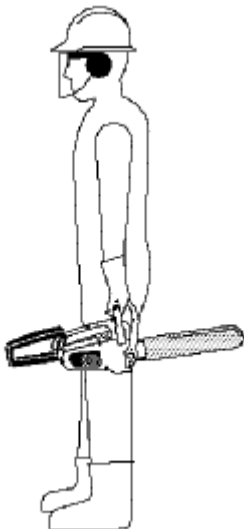

When carrying the saw on your shoulder, take extra care because of the sharpness of the chain and dogs. You must wear a long-sleeved shirt with collar turned up, gloves, and a shoulder pad. Make sure the bar, chain, and dogs are covered. There are many aftermarket bar covers available that also protect against the Muffler

Do not use chaps to cover the bar and chain to avoid damaging the chaps. Instead use a scabbard. A scabbard is a protective sleeve that fits over the guide bar, dogs and muffler of the saw. A scabbard must be used whenever a saw is carried on the shoulder. A good scabbard can be made from 4-6" fire hose.

Safely Starting a Chain Saw

- ✦ **Drop-starting a chain saw is strictly forbidden. This is the most dangerous method of starting a saw because you have no control of the saw.**
- ✦ Maintain a secure grip on the saw at all times.
- ✦ **Always start the saw with the chain brake engaged.**
- ✦ **Never let the starter rope snap back. Gradually return the starter rope to the housing.**

Start the saw on the ground or where it is firmly supported.

Take extra care when starting the chain saw. Because you won't have both hands on the saw, you will need to be more careful to maintain complete control. Remember that the location and style of on/off switches may vary with different makes of saws.

Method 1

- Engage the chain brake and ensure that the chain is not contacting anything.
- Place the saw on firm, level ground so that the chain is not in contact with the ground.
- Kneel with your right knee next to the air filter cover or pistol grip. Place your left knee to the left side of the pistol grip.
- Turn on the ignition switch. If the saw has a compression release, open it.
- If the engine is cold, choke the carburetor. Some saws' throttles open along with the choking.
- Place one hand on handlebar and the other gripping starter handle. Either hand can be used as long as the saw is held firmly.
- Firmly grasp the starter cord handle. Pull sharply with a short pull. Guide the starter cord back into the starter assembly.
- Once the saw has started, close the compression release.

NOTES:

Method 2

Standing Start

- Engage chain brake and make sure guide bar is not contacting anything on every start.
- Grasp left side of handlebar at the bend of the handlebar with the left hand.
- Brace rear of pistol grip across front of left thigh and behind right thigh.
- Assure firm footing and balance.
- Ignition switch “on”, compression release open. (If equipped.)
- Cold start – Close choke. With right hand, pull starter rope sharply and repeat until saw “pops”.
Open choke, pull starter rope sharply until saw fires and runs. “Blip” throttle to bring RPMs to idle.
- Hot start – With open choke, pull starter rope sharply until saw fires and runs.
- Guide starter rope back into starter assembly.

How To Start a Chainsaw

<https://www.youtube.com/watch?v=IFShbC6Ceds>



Stance and Hand Position

- Establish secure footing before operating a chain saw. Remove any ground debris that will not allow for stable footing.
- Maintain a balanced stance with feet spread apart, knees bent, and back straight, and have a firm grip on the chain saw.
- When cutting with a chain saw, do not overreach or lift or push with just your arms; use your legs, hips, and knees to turn your body.
- Never operate a chain saw with one hand. Because you do not have control of the saw with only one hand, you increase the risk that you will be injured if the saw kicks back.
- Chain saws are engineered for right-hand operation and should be operated with the right hand controlling the throttle. Always grip the saw firmly with both hands, the left hand on the front handlebar and the right hand on the throttle and rear handle.
- Place your fingers tightly around the rear handle and the front handlebar, keeping them between your thumb and forefinger.
- Never cut with a chain saw when the throttle lock is engaged. If you do, you cannot control the saw or the chain speed. The cold-start throttle position used when the saw is cold automatically releases when the trigger is engaged.
- Maintain cutting area control. Make sure your immediate work area is clear of people and obstacles, such as rocks, stumps, holes, or roots that may cause you to stumble or fall.
- Make sure that the saw chain does not contact any materials such as rocks, dirt, or wire. Such contact is a safety hazard and will dull the chain. The chain will require filing, or it may be damaged in ways that filing cannot correct.

Stance when operating a chainsaw

<https://www.youtube.com/watch?v=9YLSLP4qdjA>

Reactive Forces

Kickback

1. **Kickback** is the most powerful reactive force you will encounter while operating a chain saw.

Kickback can occur while felling, limbing, bucking, or brushing and slashing when the upper quadrant of the bar nose contacts a solid object or is pinched.

During kickback, the bar is forced up and back in an uncontrolled arc toward the sawyer.

Many factors determine the severity of the kickback and the arc such as:

- chain speed
- angle of contact
- condition of the chain
- speed at which the bar contacts the object

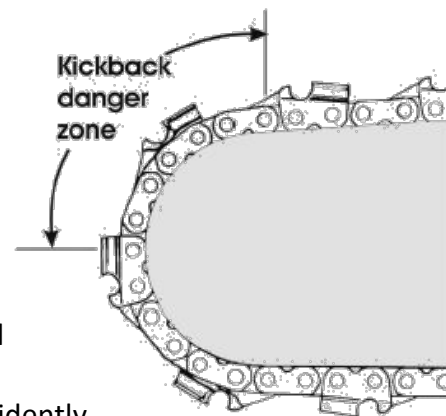

Avoiding Kickback

- Hold the saw with both hands, securely gripping the rear handle and the front handlebar between your thumb and forefinger.
- Be aware of the location of the bar nose at all times. Accidentally cutting with the top half of the guide bar nose is the most common mistake that causes kickbacks.
- Never let the bar nose contact another object.
- Never cut with the power head higher than your shoulder.
- Never overreach.
- Your stance should allow you to pull the saw smoothly out of the kerf when cutting. This technique will help to reduce kickbacks and fatigue.
- Cut one log at a time.
- Stand to the side of the kickback arc. Never rely on the chain brake to protect you from kickback injury.
- Use caution when entering the bar into a partially completed cut.
- Use a properly sharpened and tensioned chain at all times.
- Watch the kerf and the log for any movement that may pinch the chain.
- “Lock” the left elbow in situations where kickback is likely, such as limbing.
- Use your attack corner of the bar when boring.
- Using a low-kickback chain can also minimize the chance of kickback.

Pull-in

2. **Pull-in** occurs when the chain on the bottom of the bar is caught or pinched, and suddenly stops. The chain pulls the saw forward.

Avoiding Pull-in

- Always start a cut with the chain moving at half or near full speed.
- Watch the cut and the log for any movement that may pinch the bar. Use wedges to keep the cut open.

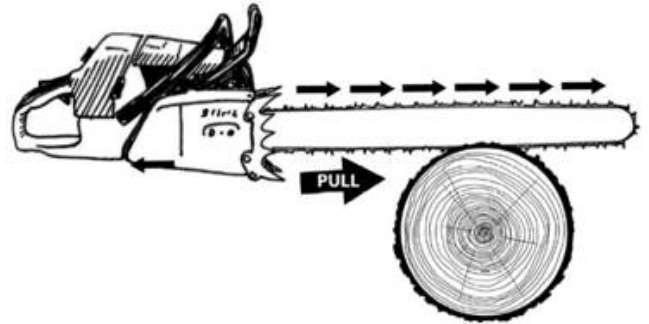

Pushback

3. **Pushback** occurs when the chain on the top of the bar is suddenly stopped by contacting another object or by being pinched. The chain drives the saw straight back toward the sawyer.

Avoiding Pushback

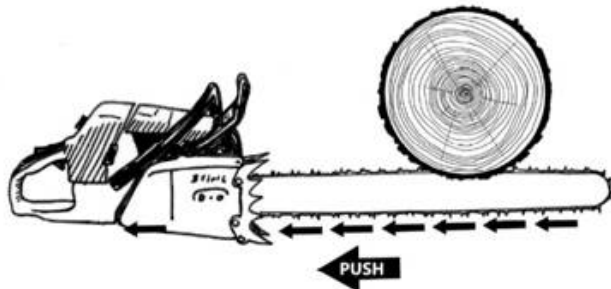

- Only cut with the top of the bar when necessary.
- Watch the kerf and the log for any movement that may pinch the top of the bar.
- Do not twist the bar when removing it from a boring cut.

Reactive forces

<https://www.youtube.com/watch?v=SqFzzhh7KfM&feature=youtu.be>

Felling a Tree

Spotters

Spotters are an important part of the tree felling process. At the start of the process, they work with the sawyer to inspect the tree and help determine the direction it will be felled. Once a felling direction is determined, the spotter will establish the safety perimeter. This may include managing traffic control if the tree is close to a road; jobs like this will require more than one spotter. Prior to the felling, the spotter can also help with clearing brush from the escape route and setting a rope in the tree, if necessary. The sawyer shall be responsible for making sure that there is a first aid kit readily available.

During the cut, the spotter is watching the top of the tree as the sawyer is cutting. They should be monitoring the movement of the tree to confirm that the tree appears to be leaning in the intended felling direction. They will also be watching for any branches that have shaken loose and might fall onto the sawyer. Other spotter jobs during the cut include traffic control, managing the safety perimeter, and keeping onlookers clear. In the event the sawyer is pinned under a tree, the spotter should be prepared to cut the tree off the sawyer or get the appropriate help to remove the tree.

After the tree has been felled, the spotter will assist in reading the binds of the branches being limbed, and then clearing the branches as the tree is being limbed. The spotter can help roll the tree trunk or set wedges as needed when the trunk is being bucked. If the spotter is also a sawyer, they can be prepared to help with limbing and bucking.

A communication system needs to be in place between the sawyer and the spotter throughout the cutting process. This can be complicated because the spotter must be a safe distance from the tree being felled and because of the noise of the saw. Most camps use 2-way radios to communicate. An ear bud can be added to the radio for communication. When the ear bud is worn under the earmuff it is easy to hear even with the saw running. Other communication methods may include hand signals or a whistle.

Keep Your Distance

<https://www.youtube.com/watch?v=eKtiUVaRt14&feature=youtu.be>

Safety Reminders for Tree Felling

- NEVER work alone.
- Make sure that all crew members have the appropriate personal protective equipment for their assignment.
- Ensure that all gear and equipment is operationally safe and functional.
- Establish a safe work plan.
- Supervise and communicate to crew members.
- Utilize ropes, cables, and pulleys at every opportunity.
- Establish escape routes.
- Always use spotters.
- Be mindful of the danger zone.
- Monitor everyone (including yourself) for fatigue.
- Communicate, communicate, communicate!

Know Your Limits

Before starting the saw, the chain saw operator must evaluate if a tree is safe to cut. Other options are always available.

✦ **IF YOU DETERMINE THAT FELLING A PARTICULAR TREE WILL BE TOO DANGEROUS, DON'T DO IT!**

In terms of complexity vs. size, a faller should not rely on tree size alone to determine complexity.

Hazards found in small trees can make them more dangerous than larger trees.

✓ **The complexity of felling a particular tree will override the size of the tree.**

Problem Trees

- Small trees
- Heavy leaners
- Root pull
- Big trees
- Hang-ups
- Sit-backs
- Snags
- Domino falling
- Fire-weakened timber
- Candlestick or stub

Know when to turn down a felling project

<https://www.youtube.com/watch?v=FDJdQYr56mk&feature=youtu.be>

NOTES:

Go/No Go Checklist for Chain Saw Operations

| Yes | No | Go/No-Go Questions |
|---------------------|----|--|
| Hazards | | |
| | | Is there a safe location where you can work without unacceptable exposure to hazards? |
| | | Is the location clear from overhead hazards, whether you are felling or bucking? |
| | | Is the location clear of any threat from other trees that may be affected by your cutting? |
| | | Does location avoid risk to other people? |
| Clearance | | |
| | | When felling, is there a clear and unobstructed lay for the tree, or can you safely create a space for it? |
| | | Is the intended lay appropriate for the lean of the tree? |
| | | When bucking or limbing, is there a clear path where the cut material can go? |
| Hinge | | |
| | | Is the portion of the tree where the felling cuts must be made sound enough to create a sufficient hinge? (The quality of the hinge must allow for appropriate directional felling given the intended lay and the lean of the tree.) |
| Snags | | |
| | | Remember to include size up of snags in limbing and bucking operations, not just during felling operations. |
| | | If felling a snag, can it be done without wedging—which could break the top out? |
| | | Can the snag be directionally felled close to its natural lean? (The holding wood can break easily.) |
| Top | | |
| | | If a tree has enough live material left to allow directional felling with a wedge, is the top sound enough to stay intact during wedging? |
| | | Is the tree free of widow-makers? |
| Platform | | |
| | | If wedges are needed, is there enough sound wood to provide a platform for the wedges to have the desired effect? (This is important during felling and bucking.) |
| Escape Route | | |
| | | Is the escape route adequate for felling? |
| | | Is the escape route adequate when limbing or bucking? |
| | | Will the escape route remain clear through any possible complications during felling or bucking? |
| | | Can you develop a clear felling plan that allows an escape route that provides a margin of error? |
| | | Are you confident you have the skill to safely and successfully complete the task? |

Remember: Any of the above questions that receive a NO answer should be discussed with a more experienced faller and possibly elevated to the next-level faller. There are trees less than 10 inches in diameter at breast height that are too dangerous for an advanced faller. Other means of taking a tree down may have to be sought out if the tree truly needs to come down.

Felling Plan Outline

1. Tree Analysis

Every tree-felling event presents hazards that should be identified before work is started. The first thing you must do after the pre-job briefing to ensure the work will be completed without injury or property damage is to inspect the tree and work area. Observe the tree for:

- Scene safety.
- Tree characteristics.
- Observe the top (widow makers, heavy branches, wind).
- Establish the lay.
- Check for snags.
- Swamp-out the base.

Size up area to work in

<https://www.youtube.com/watch?v=1YKkSysVCOc&feature=youtu.be>

NOTES:

“Look Up, Look Down, and Look All Around.”

2. Safe Area

Escape Route

After the tree is trimmed or topped as needed, but before any notch cuts are started by the sawyer (saw operator), the crew leader and sawyer must establish a clear, unobstructed escape route for the sawyer. The escape route should be at a 45-degree angle to the rear of the planned direction of fall. Each tree will have 2 possible escape routes. Choosing which is primary is based on which route is closer to the cuts you will be making. Ensure you are not exiting or crossing behind the tree to reach your escape route.

Prepare escape route

<https://www.youtube.com/watch?v=ECK8B5zZjjw&feature=youtu.be>

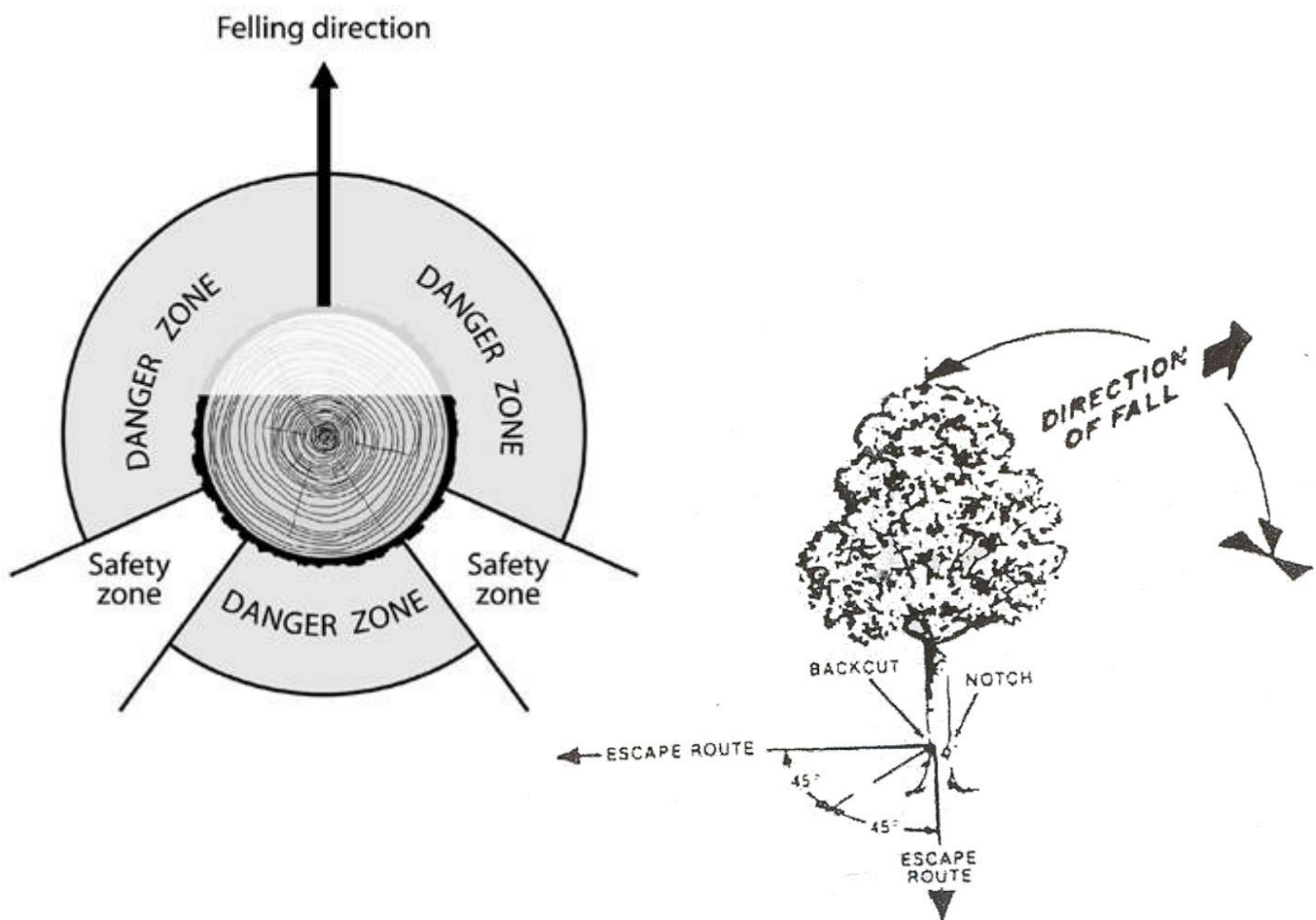

Danger Zone

Once an escape route has been established, but before any notch cuts are started by the sawyer, the crew leader and sawyer must visually inspect the felling area to make certain that all crew members are well out of the danger zone—the area equal to 1.0 times the height of the tree, extending outward from the base of the tree in all directions, covering a complete 360-degree circle around the tree.

- **Danger zone:** 1.0 times the height of the tree
- **Rope-pulling zone:** 1.5 times the height of the tree
- **Watch zone:** 2 times the height of the tree

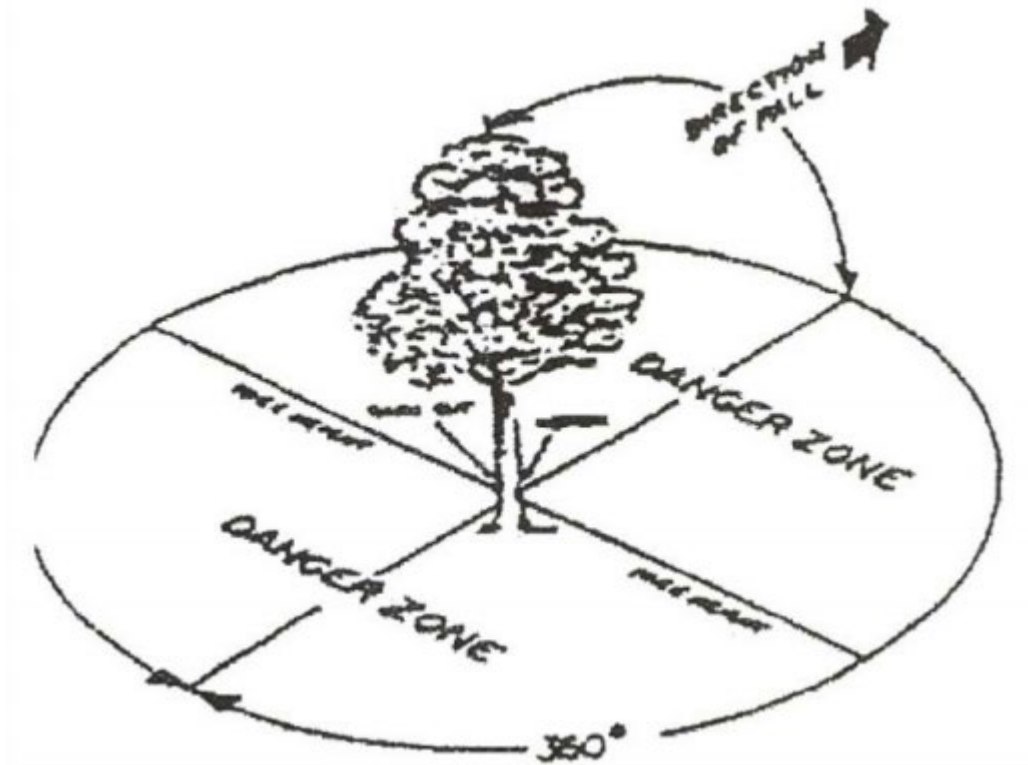

3. Planning

Several decisions must be made prior to starting to cut the tree:

- Side of the tree you will be working on.
- Exactly where each cut will be made.
- Depth of cuts.
- Angles of cuts.
- Cuts in relation to each other.
- Spotter location

The tree can be marked or scored as to keep track of what was decided

4. Communication

- Identify all hazards associated with the tree felling, communicate with crew
- Identify hazards associated with project surroundings, communicate with crew
- Communicate to crew members their individual work procedures.
- Inform the crew of any special precautions necessary to complete the job.
- Ensure that the proper personal protective equipment is used.
- Explain the lines of communication and review signaling/communication procedures.

5. Equipment

- Both the sawyer and the spotter are wearing the proper PPE.
- Whistles or radios are in place for communication between the spotter and sawyer.
- First aid kit is readily available
- Everything ready at hand.
- Wedges where you can reach them without looking down.
- Axe nearby for driving wedges
- Enough fuel in the saw for the entire job including unforeseen problems.
- Rope set in the tree if needed

6. Felling

Placement of the notch and back cut is critical as these cuts determine the direction of fall. The two cuts used in making the notch are a horizontal cut reaching about one-third of the way into the tree and another cut positioned at a 45-degree angle that meets cleanly with the inside edge of the horizontal cut. This means that the height of the face of the notch should be equal to the depth of the notch. While cutting the notch the sawyer should periodically check the gunning on the saw.

Gunning sight

<https://www.youtube.com/watch?v=dr8clUjwCKo&feature=youtu.be>

After giving an audible warning to crew members the sawyer may begin the back cut. The back cut should be a horizontal cut that is 1-1/2 to 2 inches above the notch. The back cut should stop short of the notch leaving 10% of the tree left to be the hinge, see the figure below. DO NOT cut all the way through the hinge.

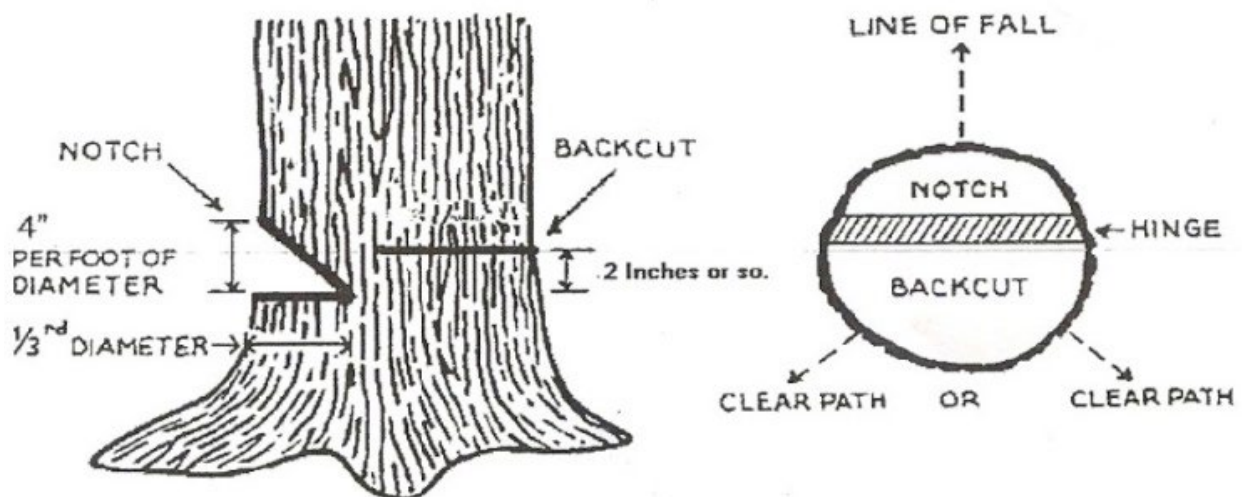

During tree felling operations, the sawyer must:

- Perform a final control check for safety of entire cutting area. Is there anyone or anything else that could possibly be affected by the felling
- Give an audible warning to crew members before starting notch cuts, starting back cuts, and felling the tree.
- Utilize the wedging plan. Properly plan your working side of the tree so you don't have to swing the ax off handed
- Leave the saw if it hampers an escape from the tree or gets pinched in the back cut.
- Leave the stump area immediately when the tree begins to fall. The sawyer continues to quickly move directly away from the tree along the designated escape route until the tree has come to rest.

Bucking a Felled Tree

The following safety precautions must be strictly adhered to when limbing; noncompliance could result in a serious injury or fatality.

A. Proper Use of Dogs

- Learn to use the saw's dogs as a pivot point when felling or bucking.

B. Situational Awareness

- Be sure to swamp out your work area to maintain safety.

C. Safe and Efficient Bucking Techniques

- Understanding directional pressure – or binds – is important for safe and efficient cutting.

D. Determining Bind

- The four types of bind are: top, bottom, side, and end.

Learn to recognize and handle:

Top Bind (tree supported at both ends)—Gravity is pulling log down between, creating compression on top of log and tension on bottom of log. To properly buck, make a shallow cut on top (compressed fiber) and finish by cutting up from bottom (tensioned fiber).

Bucking: Top Bind

<https://www.youtube.com/watch?v=jnm8WbkjzRM&list=PL9104ECDBBD56D04E&index=3&t=0s>

Bottom Bind (tree supported on one end) --Gravity is pulling log down at unsupported end, creating tension on top of log and compression on bottom of log. To properly buck, make shallow cut on bottom (compressed fiber) and finish by cutting down through top (tensioned fiber).

Bucking: Bottom Bind

<https://www.youtube.com/watch?v=ge0jwZtCeyo&list=PL9104ECDBBD56D04E&index=3>

End Bind (tree lying up and down slope)—When cut, gravity may cause up-slope portion to slide down-slope, against down-slope portion. To properly buck, insert a wedge in the saw kerf as soon as practical, to eliminate any movement.

End bind

https://www.youtube.com/watch?v=zbD_uh49lw&feature=youtu.be

Side Bind (tree in contact with more than 2 obstacles or supports)—Gravity is not an issue, but the tree is being “bent”. Any fiber on the inside of the bend will be under compression. Any fiber on the outside of the bend will be under tension. To properly buck, make a shallow cut in the compression side. Stand on compression side while making the final cut through tensioned fiber. Logs will spring away from the compression side.

Side Bind 1

<https://www.youtube.com/watch?v=8qGiVjaDEdg&feature=youtu.be>

- The energy stored within a tree's binds can generally be decreased by bucking the small and lighter portions of the tree first.
- Re-evaluate after every log has been bucked as the binds may have changed.
- Watching your saw kerf will ALWAYS tell what kind of fiber is being severed. If the kerf is opening, tensioned fiber is being severed. If the kerf is closing, compressed fiber is being severed.

Reactive forces

<https://www.youtube.com/watch?v=SqFzzhh7KfM&feature=youtu.be>

E. Safe Bucking Practices

- Warn workers who are in or below an active cutting area.

F. Boring to Buck

- Boring is a bucking method that can be used when space is limited under a log. You should gain proficiency with other bucking cuts first before attempting this cut.

G. Points to Remember

- Do a complete size up. Identify the hazards and establish your escape routes and safe zones.
- Use rocks, stumps (if they are tall enough), or sound standing trees with no overhead hazards for protection in the event the tree springs sideways toward the sawyer when the release cut is made. Binds change with log movement. Always reevaluate for binds after each section of the log is removed.
- Allow the chain to be pulled through the wood; avoid using your dogs as a pivot point to force the chain through the cut.
- Only stand as close to the log as needed during your release cut.

Limbing a Felled Tree

The following safety precautions must be strictly adhered to when limbing; noncompliance could result in a serious injury or fatality.

- A. Check for overhead and ground hazards before any limbing begins.
- B. Check for objects on the ground such as stumps, logs, and spring poles that may be hidden by the limbs of the felled tree.
- C. Maintain a firm grip on the saw with your thumb wrapped around the front handlebar during all limbing activities
- D. Identify the direction the log may roll or move when the limbs are removed and avoid being in the path of the log.
- E. Identify the limbs that are supporting the tree's weight.
- F. When limbing a log, it is recommended that sawyer's limb one side out to the top before turning around and limbing the other side on their way back (as appropriate).
- G. Limbing kickbacks occur when the upper quadrant of the bar nose contacts an object and the chain is stopped.
- H. Spring poles are limbs or small trees that are bent over and are under extreme tension.
- I. Sometimes a tree is suspended off the ground by the limb's underneath or by uneven terrain.
- J. Be sure to swamp out your work area to maintain safety.

Limbing

<https://www.youtube.com/watch?v=fxxPhWON6yk>

Appendix A

Annual Health and Medical Record

<https://www.scouting.org/health-and-safety/ahmr/>

Part A: Informed Consent, Release Agreement, and Authorization

A

Full name: _____

DOB: _____

High-adventure base participants:

Expedition/crew No.: _____

or staff position: _____

Informed Consent, Release Agreement, and Authorization

I understand that participation in Scouting activities involves the risk of personal injury including death, due to the physical, mental, and emotional challenges in the activities offered. Information about those activities may be obtained from the venue, activity coordinators, or your local council. I also understand that participation in these activities is entirely voluntary and requires participants to follow instructions and abide by all applicable rules and the standards of conduct.

In case of an emergency involving me or my child, I understand that efforts will be made to contact the individual listed as the emergency contact person by the medical provider and/or adult leader. In the event that this person cannot be reached, permission is hereby given to the medical provider selected by the adult leader in charge to secure proper treatment, including hospitalization, anesthesia, surgery, or injections of medication for me or my child. Medical providers are authorized to disclose protected health information to the adult in charge, camp medical staff, camp management, and/or any physician or health-care provider involved in providing medical care to the participant. Protected Health Information/Confidential Health Information (PHI/CHI) under the Standards for Privacy of Individually Identifiable Health Information, 45 C.F.R. §§160.103, 164.501, etc. seq., as amended from time to time, includes examination findings, test results, and treatment provided for purposes of medical evaluation of the participant, follow-up and communication with the participant's parents or guardian, and/or determination of the participant's ability to continue in the program activities.

(If applicable) I have carefully considered the risk involved and hereby give my informed consent for my child to participate in all activities offered in the program. I further authorize the sharing of the information on this form with any BSA volunteers or professionals who need to know of medical conditions that may require special consideration in conducting Scouting activities.

With appreciation of the dangers and risks associated with programs and activities, on my own behalf and/or on behalf of my child, I hereby fully and completely release and waive any and all claims for personal injury, death, or loss that may arise against the Boy Scouts of America, the local council, the activity coordinators, and all employees, volunteers, related parties, or other organizations associated with any program or activity.

I also hereby assign and grant to the local council and the Boy Scouts of America, as well as their authorized representatives, the right and permission to use and publish the photographs/film/videotapes/electronic representations and/or sound recordings made of me or my child at all Scouting activities, and I hereby release the Boy Scouts of America, the local council, the activity coordinators, and all employees, volunteers, related parties, or other organizations associated with the activity from any and all liability from such use and publication. I further authorize the reproduction, sale, copyright, exhibit, broadcast, electronic storage, and/or distribution of said photographs/film/videotapes/electronic representations and/or sound recordings without limitation at the discretion of the BSA, and I specifically waive any right to any compensation I may have for any of the foregoing.

!

NOTE: Due to the nature of programs and activities, the Boy Scouts of America and local councils cannot continually monitor compliance of program participants or any limitations imposed upon them by parents or medical providers. However, so that leaders can be as familiar as possible with any limitations, list any restrictions imposed on a child participant in connection with programs or activities below.

!

List participant restrictions, if any: None

I understand that, if any information I/we have provided is found to be inaccurate, it may limit and/or eliminate the opportunity for participation in any event or activity. If I am participating at Philmont, Philmont Training Center, Northern Tier, Florida Sea Base, or the Summit Bechtel Reserve, I have also read and understand the supplemental risk advisories, including height and weight requirements and restrictions, and understand that the participant will not be allowed to participate in applicable high-adventure programs if those requirements are not met. The participant has permission to engage in all high-adventure activities described, except as specifically noted by me or the health-care provider. If the participant is under the age of 18, a parent or guardian's signature is required.

Participant's signature: _____ Date: _____

Parent/guardian signature for youth: _____ Date: _____

(If participant is under the age of 18)

Second parent/guardian signature for youth: _____ Date: _____

(If required; for example, California)

Complete this section for youth participants only:

Adults Authorized to Take to and From Events:

You must designate at least one adult. Please include a telephone number.

Name: _____

Telephone: _____

Name: _____

Telephone: _____

Adults NOT Authorized to Take Youth To and From Events:

Name: _____

Telephone: _____

Name: _____

Telephone: _____

Prepared. For Life.®



890-021
2014 Printing

Part B: General Information/Health History

B

Full name: _____
DOB: _____
 Age: _____ Gender: _____ Height (inches): _____ Weight (lbs.): _____
 Address: _____
 City: _____ State: _____ ZIP code: _____ Telephone: _____
 Unit leader: _____ Mobile phone: _____
 Council Name/No.: _____ Unit No.: _____
 Health/Accident Insurance Company: _____ Policy No.: _____

High-adventure base participants:
 Expedition/crew No.: _____
 or staff position: _____

Please attach a photocopy of both sides of the insurance card. If you do not have medical insurance, enter "none" above.

In case of emergency, notify the person below:
 Name: _____ Relationship: _____
 Address: _____ Home phone: _____ Other phone: _____
 Alternate contact name: _____ Alternate's phone: _____

Health History

Do you currently have or have you ever been treated for any of the following?

| Yes | No | Condition | Explain |
|--------------------------|--------------------------|---|--|
| <input type="checkbox"/> | <input type="checkbox"/> | Diabetes | Last HbA1c percentage and date: |
| <input type="checkbox"/> | <input type="checkbox"/> | Hypertension (high blood pressure) | |
| <input type="checkbox"/> | <input type="checkbox"/> | Adult or congenital heart disease/heart attack/chest pain (angina)/heart murmur/coronary artery disease. Any heart surgery or procedure. Explain all "yes" answers. | |
| <input type="checkbox"/> | <input type="checkbox"/> | Family history of heart disease or any sudden heart-related death of a family member before age 50. | |
| <input type="checkbox"/> | <input type="checkbox"/> | Stroke/TIA | |
| <input type="checkbox"/> | <input type="checkbox"/> | Asthma | Last attack date: |
| <input type="checkbox"/> | <input type="checkbox"/> | Lung/respiratory disease | |
| <input type="checkbox"/> | <input type="checkbox"/> | COPD | |
| <input type="checkbox"/> | <input type="checkbox"/> | Ear/eyes/nose/sinus problems | |
| <input type="checkbox"/> | <input type="checkbox"/> | Muscular/skeletal condition/muscle or bone issues | |
| <input type="checkbox"/> | <input type="checkbox"/> | Head injury/concussion | |
| <input type="checkbox"/> | <input type="checkbox"/> | Altitude sickness | |
| <input type="checkbox"/> | <input type="checkbox"/> | Psychiatric/psychological or emotional difficulties | |
| <input type="checkbox"/> | <input type="checkbox"/> | Behavioral/neurological disorders | |
| <input type="checkbox"/> | <input type="checkbox"/> | Blood disorders/sickle cell disease | |
| <input type="checkbox"/> | <input type="checkbox"/> | Fainting spells and dizziness | |
| <input type="checkbox"/> | <input type="checkbox"/> | Kidney disease | |
| <input type="checkbox"/> | <input type="checkbox"/> | Seizures | Last seizure date: |
| <input type="checkbox"/> | <input type="checkbox"/> | Abdominal/stomach/digestive problems | |
| <input type="checkbox"/> | <input type="checkbox"/> | Thyroid disease | |
| <input type="checkbox"/> | <input type="checkbox"/> | Excessive fatigue | |
| <input type="checkbox"/> | <input type="checkbox"/> | Obstructive sleep apnea/sleep disorders | CPAP: Yes <input type="checkbox"/> No <input type="checkbox"/> |
| <input type="checkbox"/> | <input type="checkbox"/> | List all surgeries and hospitalizations | Last surgery date: |
| <input type="checkbox"/> | <input type="checkbox"/> | List any other medical conditions not covered above | |



Prepared. For Life.®

650-001
2014 Printing

B

Part B: General Information/Health History

Full name: _____

DOB: _____

High-adventure base participants:

Expedition/crew No.: _____

or staff position: _____

Allergies/Medications

Are you allergic to or do you have any adverse reaction to any of the following?

| Yes | No | Allergies or Reactions | Explain | Yes | No | Allergies or Reactions | Explain |
|--------------------------|--------------------------|------------------------|---------|--------------------------|--------------------------|------------------------|---------|
| <input type="checkbox"/> | <input type="checkbox"/> | Medication | | <input type="checkbox"/> | <input type="checkbox"/> | Plants | |
| <input type="checkbox"/> | <input type="checkbox"/> | Food | | <input type="checkbox"/> | <input type="checkbox"/> | Insect bites/stings | |

List all medications currently used, including any over-the-counter medications.

CHECK HERE IF NO MEDICATIONS ARE ROUTINELY TAKEN. IF ADDITIONAL SPACE IS NEEDED, PLEASE INDICATE ON A SEPARATE SHEET AND ATTACH.

| Medication | Dose | Frequency | Reason |
|------------|------|-----------|--------|
| | | | |
| | | | |
| | | | |
| | | | |
| | | | |
| | | | |

YES NO Non-prescription medication administration is authorized with these exceptions: _____

Administration of the above medications is approved for youth by:

Parent/guardian signature

MD/DO, NP, or PA signature (if your state requires signature)

!

Bring enough medications in sufficient quantities and in the original containers. Make sure that they are NOT expired, including inhalers and EpiPens. You SHOULD NOT STOP taking any maintenance medication unless instructed to do so by your doctor.

!

Immunization

The following immunizations are recommended by the BSA. Tetanus immunization is required and must have been received within the last 10 years. If you had the disease, check the disease column and list the date. If immunized, check yes and provide the year received.

| Yes | No | Had Disease | Immunization | Date(s) |
|--------------------------|--------------------------|--------------------------|--|---------|
| <input type="checkbox"/> | <input type="checkbox"/> | <input type="checkbox"/> | Tetanus | |
| <input type="checkbox"/> | <input type="checkbox"/> | <input type="checkbox"/> | Pertussis | |
| <input type="checkbox"/> | <input type="checkbox"/> | <input type="checkbox"/> | Diphtheria | |
| <input type="checkbox"/> | <input type="checkbox"/> | <input type="checkbox"/> | Measles/mumps/rubella | |
| <input type="checkbox"/> | <input type="checkbox"/> | <input type="checkbox"/> | Polio | |
| <input type="checkbox"/> | <input type="checkbox"/> | <input type="checkbox"/> | Chicken Pox | |
| <input type="checkbox"/> | <input type="checkbox"/> | <input type="checkbox"/> | Hepatitis A | |
| <input type="checkbox"/> | <input type="checkbox"/> | <input type="checkbox"/> | Hepatitis B | |
| <input type="checkbox"/> | <input type="checkbox"/> | <input type="checkbox"/> | Meningitis | |
| <input type="checkbox"/> | <input type="checkbox"/> | <input type="checkbox"/> | Influenza | |
| <input type="checkbox"/> | <input type="checkbox"/> | <input type="checkbox"/> | Other (i.e., Hib) | |
| <input type="checkbox"/> | <input type="checkbox"/> | <input type="checkbox"/> | Exemption to immunizations (form required) | |

Please list any additional information about your medical history:

DO NOT WRITE IN THIS BOX
Review for camp or special activity.

Reviewed by: _____

Date: _____

Further approval required: Yes No

Reason: _____

Approved by: _____

Date: _____

Appendix B

Glossary of Terms

Philmont Conservation Sawyer Training Manual

AXE – Feller’s tool used for pounding and chopping functions. Some examples of uses include pounding wedges and removing branches and limbs on larger diameter trees to be felled. Also referred to as a “pounder”.

BACKCUT – The last of the three cuts required to fall a tree. Located on the opposite side of the tree from the face cut and one to two inches above it. The back cut must never be continued to a point at which no holding wood remains.

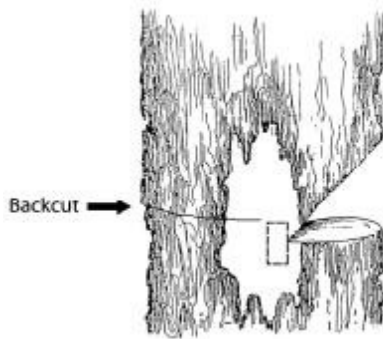

Barber chair



BARBER-CHAIR – Vertical split of a tree during the felling procedure. Commonly a result of improper face cut and/or back cut. More likely in strongly forward-leaning trees. Characterized by a portion of the fallen tree being left on the stump.

BIND – Series of pressures in the material to be cut. The two major components of bind are compression and tension. It is these directional pressures that determine the technique and procedure to be used when bucking and limbing.



BLOWDOWN – An area of previously standing trees that have been leveled by high winds.

BLM - Bureau of Land Management.

BOLE – The tree trunk.

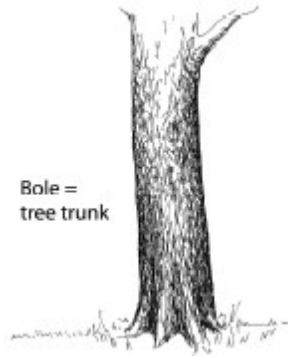

BOTTOM BIND – One of the five basic tree positions commonly encountered while bucking. A tree in a bottom bind situation is tensioned on top and compressed on the bottom. **BEGIN CUT IN THE TENSION WOOD.**

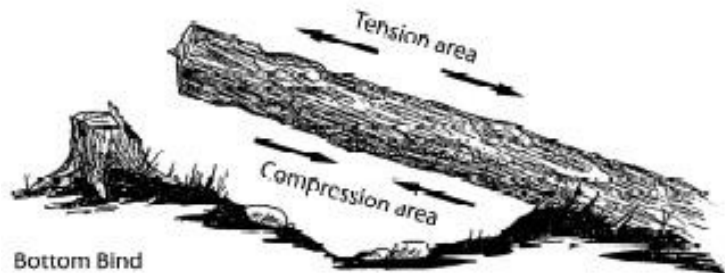

BUCK – To cut the trunk or main stem of a felled tree in to designated lengths of logs or material.



BUTT – The bottom portion of a tree trunk or log; the first bucked portion of a felled tree.

BUTT ROT – Rot within the bottom of a tree.

CAT FACE – Occurs when a tree begins to heal over a scar or deformation at the base of a tree (resembles a cat's upper lip in cross-section).

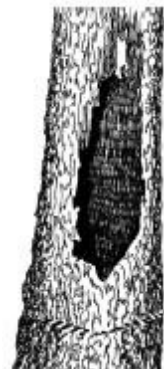

CHAPS – Personal protective equipment which covers the legs from the waist to 2" below the boot tops. They provide some protection in the event of a saw cut to the leg. All chainsaw operators and swampers must wear approved chainsaw chaps.



CLEAR CUT – The practice of removing all standing trees in a given area; usually found within logging operations.

COMMERCIAL THINNING – The removal of merchantable trees while leaving non-take trees with prescribed spacing.

COMPRESSION WOOD – In a branch or log with bind, the side of the piece of wood in which fibers are being pressed together. If a cut is initiated in compression wood, the bar will usually get pinched and/or undergo reactive forces.

CUT TREE MARK – Identifiable marks denoting trees to be cut. The reverse is said about leave tree marks which are identifiable marks denoting trees NOT to be cut. The most commonly used methods of tree identification are marking paint and flagging.

CUTTER (aka “faller”, “feller”, “bucker”, “sawyer”) – One who fells, bucks or limbs trees. Also, the cutting link of the saw chain.

DBH – “Diameter at Breast Height”, or diameter of a tree 4 1/2 feet above the ground, measured from the most uphill side.



DEBARK - To remove bark from trees or logs, usually in order to examine the soundness of the wood before felling.



DOGS (aka “dawgs”)– Metal saw attachments of 3 to 5 points on the front/right of the power head. Used as a guide bar pivot while making bucking and falling cuts (this keeps the guide bar properly aligned in the cut).



DOLMAR – A two-compartment container holding a sawyer’s mixed gasoline and bar oil.



DRC – “Diameter at Root Collar”, or the diameter of a tree at ground level on the most uphill side. Most often used with bushy species like juniper and tamarisk that often have no single well-defined trunk.

DRIVER – The projections on the underside of a saw chain that engage the drive sprocket to propel the chain around the guide bar. Also, a secondary standing tree that is felled in the direction of a hang-up that has been face cut and back cut but does not fall to the ground (a questionable felling technique not used at CREC).

DUTCHMAN/BYPASS – What occurs when the horizontal and slope cuts do not meet, and one extends beyond the other. When the tree begins to fall, the resulting kerf closes before the face cut and can change the direction in which the tree falls (sometimes used as an advanced felling technique, but often found as a mistake with inexperienced fellers).

END BIND – Encountered when bucking on steep terrain where gravity continually closes the kerf of bucking cuts. Start uphill and work your way down the trunk of the tree. Be sure severed material is not above the feller and is pushed far to the opposite side of the tree that the feller is working on.



EPA - Environmental Protection Agency.

ESCAPE ROUTE – A predetermined path of exit used by sawyers when felling or bucking. The essential components of an escape route are selection of the desired direction and distance, and a well-cleared path by which to escape. Each tree cut must have two escape routes. Each route is to be 45° off of the felling lane opposite the direction of intended fall. Remember, most faller fatalities have occurred within a 12-foot radius of the tree being felled. **NEVER TURN YOUR BACK ON A FALLING TREE!**

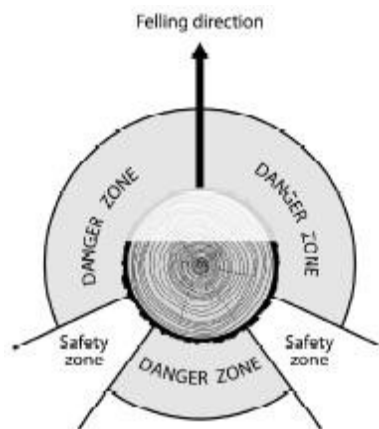

FACE - The side of the tree aligned with the predominant lean and/or the intended lay. The side of the tree opposite from the back cut.



FACE CUT (CONVENTIONAL) - A 45° or greater section of wood sawn and removed from a tree's bole. Its removal allows the tree to fall towards the predetermined lay. The face is comprised of two separate cuts, which have a constant relationship; the horizontal cut must be of significant but limited depth (1/4 to 1/3rd of the diameter) to allow adequate hinge wood; the sloping cut must be angled enough to allow a wide opening and the two cuts must meet each other without bypassing (i.e., forming a Dutchman).

A FALLER – A USFS employee who is being trained or evaluated in introductory level, non-complex chain saw operations. Work of A fallers must be supervised by a qualified B Faller or C Faller.

B FALLER - A USFS employee who previously has been certified at the A Faller level and has demonstrated sufficient judgment, skill and knowledge to be trained or certified in moderately complex chain saw operations. Certified B Faller individuals may work independently on project or fire line assignments up to their level of skill. They demonstrate the judgment to decline assignments that exceed their skill level.

C FALLER - A USFS employee who has demonstrated judgment and proficiency in correctly handling complex sawing and felling in wildland fire operations. A C Faller may certify sawyers as A, B or C Fallers.

FELLING LANE – A prepared area in which a faller is to drop a tree.

GROUNDING - Contact between a container and the ground point, usually by wire, to prevent generation of static electrical sparks. Fuel containers and chain saws must always be filled on the ground, not in a vehicle (or on a vehicle's tailgate), to establish an adequate ground.



GUIDE BAR – Long, thin projection of the chain saw upon which the saw chain travels. Improper use of the bar may result in injury or saw damage. The top of the guide bar tip can cause kickback and should be kept clear while cutting. Referred to as simply a “bar” around CREC.

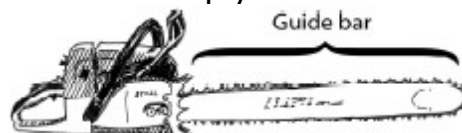

GUNNING SIGHTS – Lines on the power head that are perpendicular to the guide bar. Used as a tool to aim the direction in which a tree will fall. When the sights are aimed at the felling lane, the bar will be perpendicular to the felling lane. Remember, the horizontal cut and back cut of the conventional face cut are to be perpendicular to the felling lane.



HANG-UP – An instance in which one tree is felled into another and becomes lodged, preventing the tree from safely falling to the ground. You have now created an extremely dangerous situation! **NEVER JUST LEAVE A HUNG- UP TREE!** Leave someone to watch the tree and notify your Supervisor immediately unless you have been specifically trained in taking down hang-ups. If the tree cannot be safely taken down, you must warn all individuals working in the vicinity of the hang-up. You must also flag a 2 1/2 tree-length perimeter around the hang-up to warn anyone who may enter the area. Severe consequences will fall upon anyone who leaves a hang-up and does not follow the above instructions for dealing with a hang-up. Corps members are expected to report hang-ups to their Supervisor even if they were successful in felling the tree themselves.



HAZARD TREE - A standing tree that presents a hazard to people due to conditions such as, but not limited to, deterioration or physical damage to the root system, trunk, stem, or limbs, or the lean or proximity of the tree in relation to obstacles or property. Felling hazard trees requires a minimum of B Faller equivalent training.

HEARTWOOD – The inner layers of a growing tree that no longer contain functional cells and have been filled with resins. These resins make the wood more durable, but also more brittle when in the holding wood (see below).

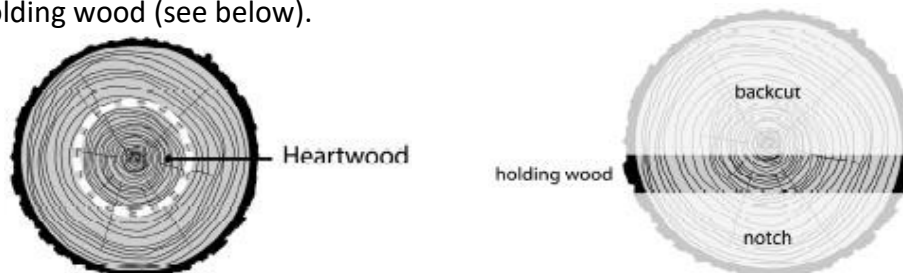

HINGE (aka “holding wood”) – The section of wood not cut in the felling sequence. Its purpose is to guide the falling tree in the desired direction while preventing the tree from coming off the stump until it has been committed to the face. Holding wood thickness should be approximately 10% of DBH (e.g., 1” for a 10” tree). **ALWAYS MAINTAIN THE INTEGRITY OF YOUR HINGE!**

HORIZONTAL CUT – The first cut of the conventional face cut. Should be level (parallel to the horizon, not necessarily parallel to the ground), sever no more than 1/3 the diameter of the tree and be perpendicular to the felling lane. See “FACE CUT”.

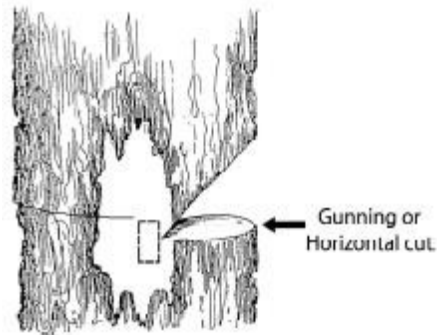

JOB HAZARD ANALYSIS (JHA) – A written document that describes the potential hazards of the work site, along with all agency policies, controls and work practices selected to minimize those hazards. At CREC, the green Safety Sheets used to conduct Safety Circles each morning are used in place of JHAs.

KERF – The resulting space created by the cutting of the chain in wood.

KICKBACK –A reactive force which causes the guide bar tip to move suddenly up and back towards the sawyer. Kickback generally occurs when the top of the guide bar tip contacts solid material while the chain is in motion. Kickback is dangerous, causing approximately one-fifth of all chainsaw injuries. **STAY IN CONTROL OF YOUR GUIDE BAR TIP AND BE AWARE OF ITS LOCATION AT ALL TIMES!**

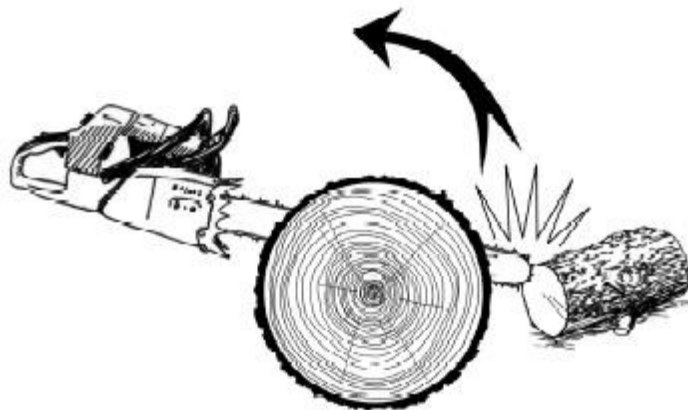

LCES – An Acronym used by wildland firefighters to refer to their safety system of Lookouts, Communications, Escape Routes and Safety Zones. Pronounced “Laces”, and sometimes Awareness is stuck in there as well.

LEAN – The directional tilt of a standing tree away from the natural vertical position of the tree. Lean can be established using an axe as a plumb bob. Lean can be influenced by the uneven distribution of weight in the crown of a tree.

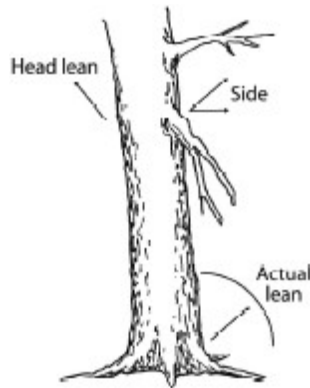

LEANER – A tree that naturally leans heavily. These trees are more susceptible to barber-chairing and often require advanced felling techniques; consult your Supervisor before felling.

LIMBING – Removing branches and limbs from a standing or a felled tree.

MSDS - Material Safety Data Sheet - A compilation of information required under the Occupational Safety and Health Administration (OSHA) Hazard Communication Standard that outlines the identity of hazardous chemicals and fire hazards, exposure limits, and storage and handling precautions.

NPS - National Park Service.

OFFSIDE – The opposite side of the tree from where the faller stands while bucking and falling (aka “bad side”). If the tree has any side lean, the offside is usually on the side the tree is leaning towards.

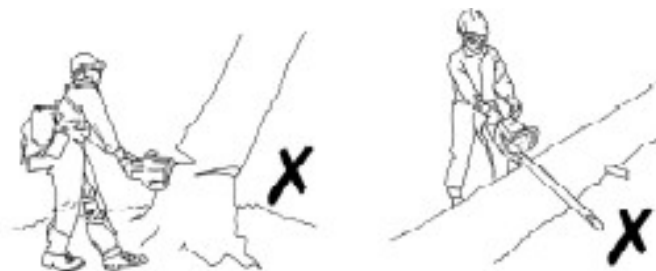

PIE CUT (aka “wedge cut”) - A section cut from a tree during the bucking sequence to allow for the directional pressures of various bind situations. A pie cut allows the tree to bend more gradually instead of pinching the bar or snapping apart. Also used at times by advanced sawyers in taking down hang-ups.

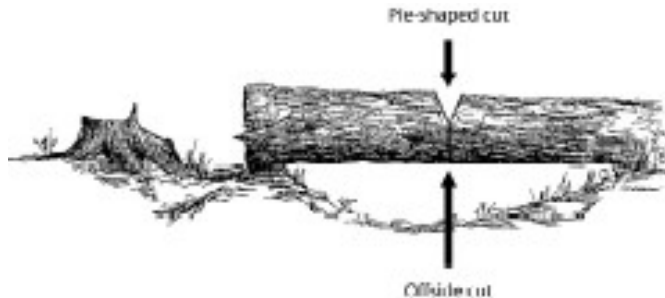

PISTOL GRIP – An S shape bend in the trunk growth of a tree which can make determining lean more difficult. Sometimes used to refer to the rear handle of the chainsaw.

PLUMB BOB – A tool used to establish vertical. Uses a weight suspended on the end of a string or stick and gravity to form a vertical line. When referenced with the trunk of a tree, any variation of the trunk in relation to the vertical line created by the suspended weight will determine the lean of a tree. A felling axe may be used as a plumb bob.



PULL IN - A reactive force which occurs when the chain on the bottom of the bar is caught or pinched, and suddenly stops. The saw is pulled forward, away from the sawyer.

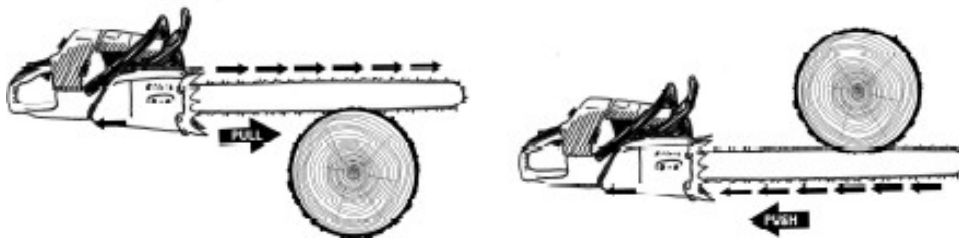

PUSH BACK - A reactive force which occurs when the chain on the top of the bar is suddenly stopped by contacting another object or by being pinched. The saw is forced straight back toward the sawyer.

SAPLING - A small tree under 4 inches DBH. Many saplings in a tight group are referred to as a “dog hair” thicket.

SAPWOOD – In growing trees, the outer layers of wood containing cells that transport water, nutrients, and reserve material. Sapwood is more flexible and resilient than heartwood.

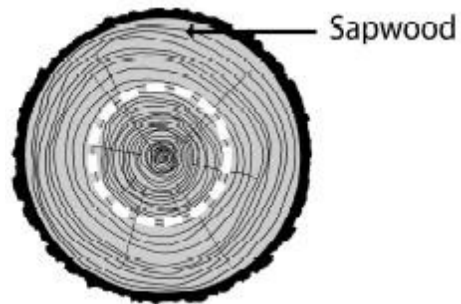

SCABBARD – A protective sleeve that fits over the guide bar, dogs and muffler of the saw. A scabbard must be used whenever a saw is carried on the shoulder. CREC’s scabbards are made out of 4-6” fire hose.

SCHOOL-MARM – The natural dividing of a tree’s base into at least two sections and/or the natural dividing of the tree’s top into at least two sections.



SHOULDER PAD – A leather, canvas or felt pad threaded through suspender to protect the body from the chain and/or dogs while carrying the chainsaw over the shoulder. These are not used at CREC: saws may be carried on the shoulder only when in a scabbard.

SIDE BIND – One of the five basic tree positions commonly encountered while bucking. A tree in a side bind situation is compressed on one side and tensioned on the other. **BEGIN THE CUT IN TENSION WOOD!**

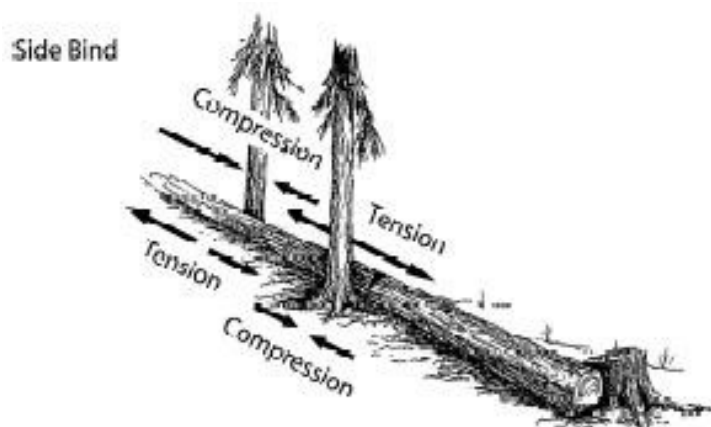

SIDEWINDER – A tree that falls in an unintended direction.

SITBACK – When a tree settles back on the stump, closing the kerf of the back cut. Generally, a result of improper determination of the tree's lean and/or of wind, and a failure to place a wedge in the back cut.



SLOPE CUT – The second cut made in a conventional face cut. The slope cut should be at a 45° or greater angle to the horizon, perpendicular to the felling lane, and exactly meeting the horizontal cut. See "FACE CUT".

SNAG – Any dead and standing tree. Snags can be important to many species of wildlife. They are considered hazard trees because they can be more dangerous than live trees, and therefore require B Faller equivalent training or higher to fell; consult your Supervisor before felling any snag, and always be aware of snags in your felling zone.



SNAP TOP – A tree with a broken off top resulting from rot and/or wind (usually classified as a hazard tree).

SOUND - Descriptor used in tree felling, especially snags, in reference to the absence of rot in the standing tree. Presence or absence of rot will change the noise made when sounding a tree (see below).

SOUNDING - Using the head of the falling axe to strike the tree to determine its soundness.

SPIKE TOP – A live tree with a dead and barkless top (usually classified as a hazard tree).



SPRING POLE – A limb or sapling that is bent underneath the weight of a felled tree. Carelessly cutting a spring pole can result in the sudden, unexpected release of stored tension, which can cause the branch or sapling to whip up towards the sawyer, often taking the guide bar with it. The correct technique is to gradually relieve tension through several small partial cuts in the tension wood, allowing the bent limb or sapling to progressively return to an unstressed position.

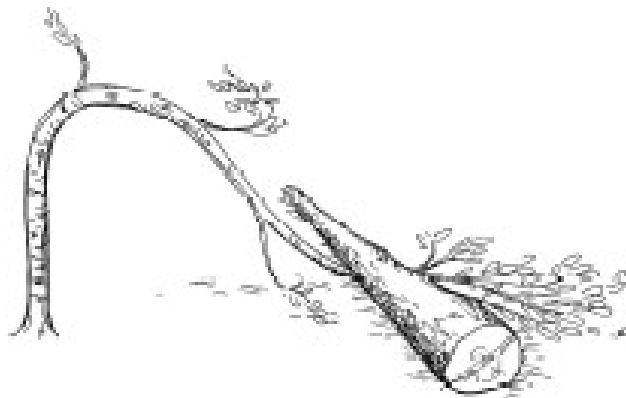

STAGGED PANTS – Pants in which the cuffs have been removed so as not to snag on objects while working or moving through escape routes. Generally, not done at CREC.

STUB – Part of a branch that is not cut flush to the trunk, but left protruding from the trunk. Small stubs are often helpful when moving logs to swamp piles but are inappropriate for firewood because they prevent proper stacking. If cut at an angle, these are sometimes referred to as “pig ears” and can cause injury. This term is sometimes also used to refer to stumps of small trees which have not been cut flush with the ground (also called “punji sticks” if cut at an angle).

STUMP SHOT – The height difference between the horizontal cut and the back cut. The difference in height establishes a step that will prevent a tree from jumping back over the stump toward the faller. Proper stump shot is approximately the same as hinge thickness, i.e., ~10% of Dbh.

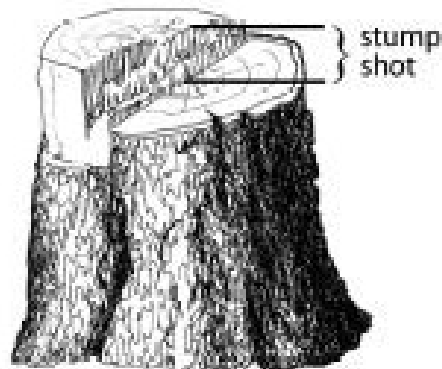

SWAMPING (aka “slashing”)– The piling of tree remains (aka “slash”) after being felled, bucked and limbed. Slash piles are usually allowed to dry for a year or more and then burned. At CREC, slash piles are created in a specific manner, which will be demonstrated on the first field day. The goals in building a good slash pile should be to make a pile is stable, burns well and minimizes the area of ground impacted by the burn.

THINNING – The removal, by prescription, of undesirable and overcrowded trees from a designated area of land to help restore forest environments and to stimulate leave-tree growth. Reduction of ground and “ladder” fuels also greatly reduces the chances that surface fires will spread into the tree-tops. Crown fires are extremely dangerous, destructive and hard to control.

TREE PREP – The act of clearing and removing debris from around a tree to be felled and from escape routes. The purpose of tree prepping is to create unobstructed footing and a clear working environment.

THROW BACK (aka “blow back”) - Ground debris, limbs or tree-tops thrown back toward the faller as the tree falls to the ground. Usually occurs when felling large snags. The faller should wait to return to the stump until everything has come to rest.

TOP BIND – One of the five basic tree positions commonly encountered while bucking. A log in a top bind situation is compressed on top and tensioned on the bottom. **BEGIN CUT IN THE TENSION WOOD!**

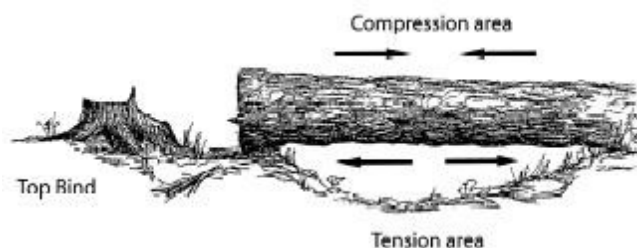

USDA - United States Department of Agriculture.

USFS - United States Forest Service.

WEDGE – A plastic or magnesium tool used by a faller to redistribute a tree’s weight to a desired direction and to prevent a tree from sitting back. Also used to prevent the guide bar from being pinched while bucking.

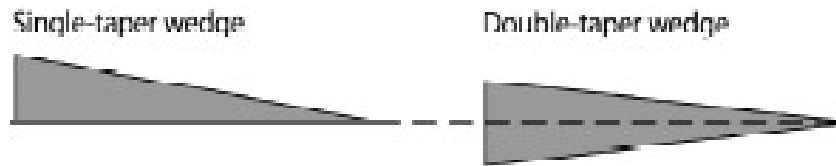

WIDOW

Loose limbs, treetops or large bark pieces that can become dislodged and fall. **65% of logging fatalities are from being stuck by falling objects.** Look for widow makers **BEFORE** you get under the tree.

MAKER –

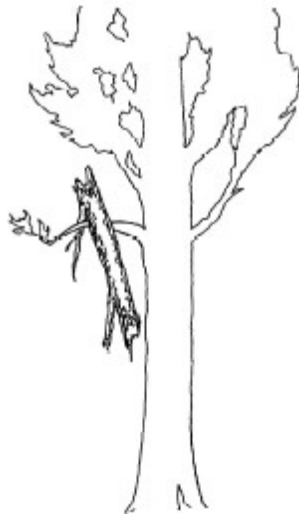

WINDFALL – Trees uprooted or that have broken tops due to high winds. These trees pose extra dangers and should be dealt with by Corps members only under close supervision.



Appendix C

BSA SAFETY MOMENT: CHAIN SAW SAFETY

[https://filestore.scouting.org/filestore/HealthSafety/pdf/680-055\(17\)%20Chainsaws_WEB.pdf](https://filestore.scouting.org/filestore/HealthSafety/pdf/680-055(17)%20Chainsaws_WEB.pdf)



BOY SCOUTS OF AMERICA
HEALTH AND SAFETY

BSA SAFETY MOMENT CHAIN SAW SAFETY

SUMMARY

Operating a chain saw is inherently hazardous. Proper maintenance, personal protective equipment, and correct technique are critical components of safe chain saw operation. Potential injuries can be minimized by using proper personal protective equipment and safe operating procedures.

GENERAL INFORMATION

Boy Scouts of America properties rely on chain saws to help clear trails, remove deadfalls, clear timber, and stockpile wood for campfires and heating buildings. To allow for this use, specific guidelines for safety have been adapted for use at all BSA activities. The [National Camp Standards](#) require that chain saw operators be at least 18 years old and meet one of the following: be a professional forester; be a certified arborist; have received training in chain saw techniques from a Ranger section of National Camping School; have written documentation of having other training in these techniques that is recognized by the state or federal government; or have successfully completed BSA Chain Saw Safety Training course, No. 20-136.

LET'S LOOK AT ACTUAL SAFETY STEPS AND OPERATION:

Before Starting a Chain Saw

- Check controls, chain tension, and all bolts and handles to ensure that they are functioning properly and that all are adjusted according to the manufacturer's instructions.
- Make sure that the chain is always sharp and the lubrication reservoir is full.
- Start the saw on the ground or on another firm support. Drop-starting, or the act of pushing the saw away from the body with one hand while simultaneously pulling on the starter cord handle with another, is never allowed.
- Start the saw at least 10 feet from the fueling area, with the chain's brake engaged.

Fueling a Chain Saw

- Use approved containers for transporting fuel to the saw.
- Dispense fuel at least 10 feet away from any sources of ignition when performing construction activities. No smoking during fueling.
- Use a funnel or a flexible hose when pouring fuel into the saw.
- Before refueling, turn off the chain saw and let the motor cool down. Never attempt to fuel a running or HOT saw.

Chain Saw Safety

- Clear away dirt, debris, small tree limbs, and rocks from the saw's chain path. Look for nails, spikes, or other metal in the tree before cutting.
- Shut off the saw or engage its chain brake when carrying the saw on rough or uneven terrain.
- Keep your hands on the saw's handles, and maintain secure footing while operating the saw.
- Proper personal protective equipment must be worn when operating the saw, which includes hand, foot, leg, eye, face, hearing, and head protection.
- Do not wear loose-fitting clothing.
- Be careful that the trunk or tree limbs will not bind against the saw.
- Watch for branches under tension. They may spring out when cut.
- Gasoline-powered chain saws must be equipped with a protective device that minimizes chain saw kickback.
- Be cautious of saw kickback. To avoid kickback, do not saw with the tip. If equipped with a tip guard, keep it in place.

RESOURCES



- OSHA Chain Saw Safety QuickCard: www.osha.gov/Publications/3269-10N-05-english-06-27-2007.html
- Stihl Chain Saw Safety Manual: https://m.stihlusa.com/WebContent/CMSFileLibrary/InstructionManuals/Chainsaw-Safety-Manual_1.pdf
- BSA Chain Saw Training : www.scouting.org/filestore/doc/20-136.doc
- BSA Guide to Safe Scouting: www.scouting.org/health-and-safety/gss/

680-055
Rev. 4/18

Appendix E

BSA SAFETY MOMENT: HAZARD TREES

[https://filestore.scouting.org/filestore/HealthSafety/pdf/680-055\(19\)Hazard_Trees_WEB.pdf](https://filestore.scouting.org/filestore/HealthSafety/pdf/680-055(19)Hazard_Trees_WEB.pdf)



BOY SCOUTS OF AMERICA
HEALTH AND SAFETY

BSA SAFETY MOMENT HAZARD TREES

SUMMARY

According to the U.S. Forest Service, our nation's forests are experiencing declining health conditions. Broken tops, widow-makers (broken or hanging limbs), and root rot in many tree species along with insect infestations, lightning, wind events, drought, and abundant moisture have led to the creation of abnormally high numbers of "hazard trees." Hazard trees include dead trees, live trees with dead parts, and live trees that are unstable due to defects and are within striking distance of people or property.

These hazard trees don't just affect our Scouting family during storms. They can fall—and have fallen—at unpredictable times, even when weather conditions are favorable.

GENERAL INFORMATION

Here are some tips to prevent a hazard tree from affecting your event:

- Assess your site. Look up, look down, and look all around when parking a vehicle, hiking on the trail, or selecting a campsite.
- Avoid campsites with hazard trees. Dead trees and dead limbs may fall at any time. Trees without needles, bark, or limbs may indicate structural defects.
- If a campsite does have hazard trees but must be used, be sure that all tents, chairs, hammocks, and work areas are outside the failure zone, or fall radius, of those trees. The fall radius on flat ground is 1½ times the height of the tree or tree part that could fail. Sloping ground could increase the danger zone.
- Don't use dead trees, hazard trees, or other unstable objects to support tents, canopies, or hammocks.
- Check the environment constantly for changes, including the weather, as storms can increase the likelihood of trees or parts of trees falling.
- Communicate about hazard trees to others, such as units, crews, or camp authorities.

RESOURCES

- U.S. Forest Service—Hazard Trees: www.fs.fed.us/visit/know-before-you-go/hazard-trees
- U.S. Forest Service—Trees: www.fs.fed.us/learn/trees
- U.S. Department of Agriculture—Hazard Tree Safety: www.fs.usda.gov/Internet/FSE_DOCUMENTS/stelprdb5433697.pdf
- Trees Are Good—Recognizing Tree Risk: www.treesaregood.org/portals/0/docs/treecare/TreeRisk.pdf
- Trees Are Good—Managing Hazards and Risk: www.treesaregood.org/treeowner/treehazards

Photo: Shutterstock.com—©VDB Photos

680-055
June 2019

Appendix F

BSA SAFETY MOMENT: HAZARD TREES AND HAMMOCKS – JACK’S STORY

[https://filestore.scouting.org/filestore/HealthSafety/pdf/680-055\(19\)Hazard_Trees_WEB.pdf](https://filestore.scouting.org/filestore/HealthSafety/pdf/680-055(19)Hazard_Trees_WEB.pdf)



BOY SCOUTS OF AMERICA
HEALTH AND SAFETY



BSA SAFETY MOMENT

HAZARD TREES AND HAMMOCKS—JACK’S STORY

SUMMARY

On November 5, 2016, Jack Rose, an 11-year-old member of a local troop, was on an overnight backpacking trip with his father as well as with adult leaders and Scouts from his troop. The group was in the backcountry portion of the Daniel Boone National Forest. The unit camped at a location that had what may be called a hazard tree. The label “hazard tree” includes dead trees, live trees with dead parts, and live trees that are considered unstable (due to structural defect) and are within striking distance of people or property. A hammock was tied to a dead tree that later fell on Jack’s tent after everyone retired for the evening. Tragically, Jack was killed when the tree struck him.

LESSONS LEARNED

1. Avoid campsites with hazard trees. Dead trees and dead limbs may fall at any time. A lack of needles, bark, or limbs on a tree may indicate structural defects. Trees with broken tops, multiple downed limbs, ants, or an abundance of woodpecker holes may have internal rot.
2. If a campsite that contains a hazard tree must be used as a campsite, be sure to place tents, chairs, and hammocks outside the fall radius of the hazard tree and advise campers to avoid this hazard tree failure zone. The fall radius on flat ground is considered one to one and a half times the height of the tree or tree part that could fail.
3. Have a contingency plan for campsite selection because your first choice may not be available, especially on public lands.

WHAT YOU CAN DO

- Share Jack’s story before your next camping trip and understand that hazard trees can fall unpredictably.
- Ensure qualified supervision is in place with the appropriate level of outdoor training.
- Know and understand all park rules and regulations.
- Remember to examine campsites to identify any hazard trees.
- Always test a hammock to ensure it is hung correctly before putting your full weight into it.
- Don’t use hazard trees or unstable supports to anchor your hammock.

RESOURCES

- Hammock Camping Safety Moment: www.scouting.org/health-and-safety/safety-moments/hammock-camping
- ENO General Safety Information: www.eaglesnestoutfittersinc.com/safety/
- U.S. Forest Service—Hazard Trees: www.fs.fed.us/visit/know-before-you-go/hazard-trees

Jack’s story is shared at the request of his family.

680-055
April 2019

Appendix G

Practical Activity Checklist

Instructions

As participants complete tasks in each area, use the following checklists to ensure all of the areas covered in the training are demonstrated correctly.

Each participant should demonstrate proficiency in each area of the checklist before being certified as trained.

1. Explain, discuss and put on your Personal Protective Equipment (PPE) for the job.
 - Hard hat for head protection
 - Hearing protection - earmuffs or plugs
 - Eye / Face Protection - safety glasses and/or logger type mesh screens
 - Leg Protection – cut resistant chaps / long pants
 - Foot Protection – steel toe / cut resistant boots
 - Hand Protection – gloves
2. Explain and discuss chainsaw maintenance and inspection as per the Chain Saw Maintenance section
 - Check the Guide bar and chain lubrication
 - Check the throttle trigger for smooth operation. Be sure the trigger cannot be pulled until the throttle trigger lockout is depressed.
 - Clean the chain brake and check that it engages and disengages properly.
 - Clean or replace the air filter as necessary. Check for damage and holes.
 - The guide bar should be turned daily. Check the chain oil hole in the bar to be sure it is not clogged. Clean the bar groove. Lubricate the sprocket tip on the bar.
 - Check the chain oiler to be sure the bar and chain receive proper lubrication.
 - Sharpen the saw chain and check its tension and condition. Check the sprocket for wear; replace if necessary.
 - Check the starter cord and assembly for damage and wear. Clean the air intake slots on the starter housing.
 - If necessary, retighten loose nuts and screws, using proper tools and taking care not to damage threads or crack casings.

- Test the ignition switch to be sure it shuts off the engine.

3. Select a tree to fell using the

a. Tree Felling Procedures

- Observe the top (widow makers, heavy branches, wind).
- Establish the lay.
- Check for snags.
- Swamp-out the base.
- Size up (lean, sounding, conks).
- Determine an escape route.
- Walk out the lay.
- Re-examine the escape route.
- Face the tree.
- Check the gunning.
- Warning.
- Back cut.
- Escape the stump.
- Analyze the operation.

b. 6 Steps to Fell a Tree

- Step 1 - Inspections
- Step 2 – Job Briefing
- Step 3 – Supervise and Communicate
- Step 4 – The Escape Route
- Step 5 – Danger Zone
- Step 6 – Notch and Back Cut

c. The Tree Felling Plan Outline

- Risk analysis
- Scene safety.
- Tree characteristics.
- Key locations
- Side of the tree you will be working on.
- Exactly where each cut will be made.
- Depth of cuts.
- Angles of cuts.
- Cuts in relation to each other.
- Primary escape route
- How it relates to the cuts you will be making.
- Ensure you are not exiting or crossing behind the tree.
- Plan on exiting at close to a 45-degree angle when possible.
- Equipment checks
- Everything ready at hand.
- Wedges where you can reach them without looking down.
- Axe nearby.
- Enough fuel in the saw for the entire job including unforeseen problems.
- Wedging plan
- Properly plan your working side of the tree so you don't have to swing off handed.
- Cutting area control
- Final control check for safety of entire cutting area. Is there anyone or anything else that could possibly be affected by your cutting?

d. Fell a tree

- Five Basic Elements of Felling a Tree:
- Performing a size up and creating a felling plan
- Establishing cutting area control
- Making the undercut
- Making the back cut with wedging
- Exiting safely

4. Limb a tree

- Check for overhead and ground hazards before any limbing begins.
- Check for objects on the ground such as stumps, logs, and spring poles that may be hidden by the limbs of the felled tree.
- Maintain a firm grip on the saw with your thumb wrapped around the front handlebar during all limbing activities
- Identify the direction the log may roll or move when the limbs are removed and avoid being in the path of the log.
- Identify the limbs that are supporting the tree's weight.
- When limbing a log, it is recommended that sawyers limb one side out to the top before turning around and limbing the other side on their way back (as appropriate).
- Limbing kickbacks occur when the upper quadrant of the bar nose contacts an object and the chain is stopped.
- Spring poles are limbs or small trees that are bent over and are under extreme tension.
- Sometimes a tree is suspended off the ground by the limbs underneath or by uneven terrain.
- Be sure to swamp out your work area to maintain safety.

5. Buck a tree

- Proper Use of Dogs
- Situational Awareness
- Safe and Efficient Bucking Techniques
- Determining Bind
- Safe Bucking Practices
- Boring to Buck

6. Points to Remember

- Do a complete size up. Identify the hazards and establish your escape routes and safe zones.
- Use rocks, stumps (if they are tall enough), or sound standing trees with no overhead hazards for protection in the event the tree springs sideways toward the sawyer when the release cut is made.
- Binds change with log movement. Always.
- Allow the chain to be pulled through the wood; avoid using your dogs as a pivot point to force the chain through the cut.
- Only stand as close to the log as needed during your release cut.

THE INFORMATION CHECKED IN THIS TRAINING PLAN HAS BEEN THOROUGHLY REVIEWED WITH THE TRAINEE.

PARTICIPANT

TRAINER

DATE

COMMENTS
